

Inline Centrifugal Fans MUC Series



MUC310 - 710 Series

Backward curved centrifugal impeller with high quality external rotor motor for high pressure exhaust applications.

Common Applications

- Suitable for supply or exhaust applications
- Duct mounted fans

Features

- Capable of handling up to 4200 L/Sec and static pressure up to 900 Pa
- Performance tests are in accordance with ISO5801 (2017)
- Noise level tests are under BS848 Part 2 (1985) and DIN 45635 Part 38
- Fan diameter from 310mm to 710mm
- Sealed for life ball bearing motors
- Motors in single or three phase, 2 speed and/or speed controllable.

Order Code

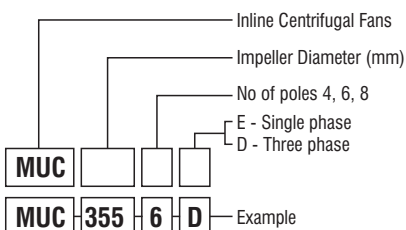

MUC Series

4 Pole

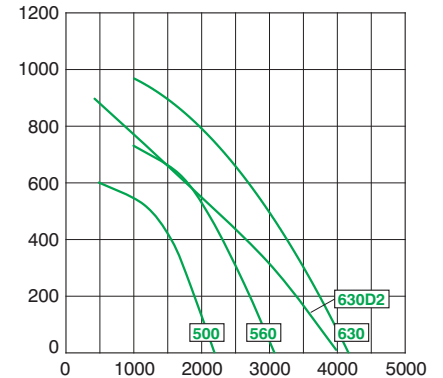
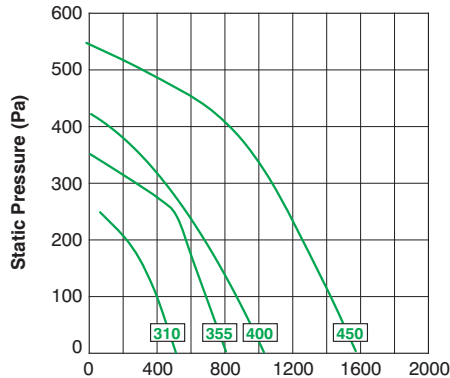

Airflow (L/s)

6 Pole

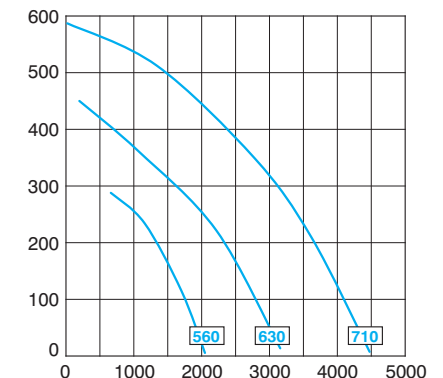
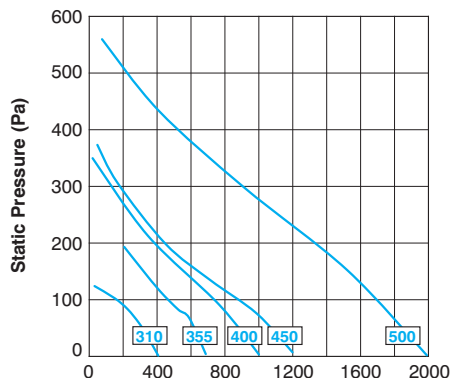

Airflow (L/s)

8 Pole

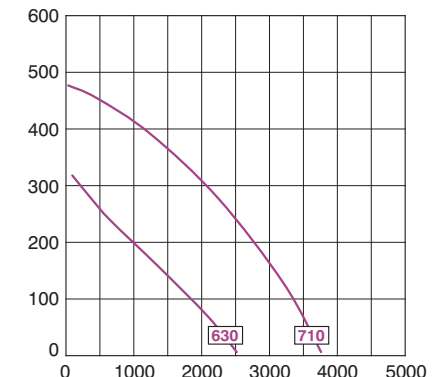
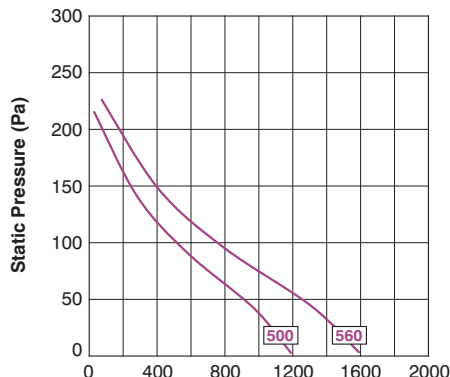

Airflow (L/s)

Inline Centrifugal Fans MUC Series



Technical Data ■ 4 POLE ■ 6 POLE ■ 8 POLE

Model	Speed r/s	1 phase		3 phase		Octave Band Frequency Lw db (A)								SPL dB(A) @3m
		KW	Amps	KW	Amps	63	125	250	500	1k	2k	4k	8k	
MUC310/4	23	0.13	0.55	0.11	0.25	27	51	55	65	67	54	58	51	49
MUC310/6	15	0.08	0.35	-	-	28	34	38	40	42	41	32	22	26
MUC355/4	22	0.18	0.83	0.25	0.49	24	48	53	67	69	67	63	49	52
MUC355/6	17	0.12	0.54	0.18	0.28	54	59	57	54	45	44	41	35	42
MUC400/4	22	0.52	2.43	0.44	0.77	25	50	48	62	52	50	49	49	48
MUC400/6	17	0.17	0.80	0.31	0.50	41	50	57	54	51	50	52	48	40
MUC450/4	21	0.73	3.30	0.74	1.46	42	57	61	65	60	59	50	61	48
MUC450/6	15	0.24	1.05	0.36	0.67	41	48	52	54	50	51	55	53	40
MUC500/4	23	1.30	5.70	1.35	2.60	44	62	62	70	64	64	61	65	53
MUC500/6	19	0.38	1.65	0.83	1.40	44	56	62	60	57	57	52	55	46
MUC500/8	10	-	-	0.23	0.49	38	50	56	54	51	50	45	49	39
MUC560/4	22	-	-	2.16	4.10	46	63	65	64	62	59	57	62	50
MUC560/6	16	0.62	2.80	1.35	2.30	50	52	58	58	56	55	58	61	45
MUC560/8	10	-	-	0.35	0.58	47	48	58	53	55	51	54	44	41
MUC630/4	23	-	-	3.90	6.60	50	69	72	73	71	70	73	70	65
MUC630/4D2	19	-	-	2.80	4.60	50	60	66	72	71	63	57	62	56
MUC630/6	15	-	-	1.10	2.20	50	56	62	59	61	57	54	55	46
MUC630/8	11	-	-	0.65	1.15	42	49	54	51	52	50	55	40	39
MUC710/6	15	-	-	2.00	3.90	56	68	76	69	70	68	65	59	57
MUC710/8	12	-	-	1.40	2.50	50	62	70	63	64	62	59	53	52

Note: Amperages shown are a guide only. Electrical Data in **Bold** refers to Star/Delta motors.

Technical Data

Model	Kg	A	B	C	D	E
MUC310	20	520	400	450	485	485
MUC355	30	520	400	450	485	485
MUC400	45	570	450	500	535	535
MUC450	50	620	495	550	585	585
MUC500	55	720	525	650	685	685
MUC560	60	780	550	710	745	745
MUC630	65	870	625	800	835	835
MUC710	65	970	625	900	935	935

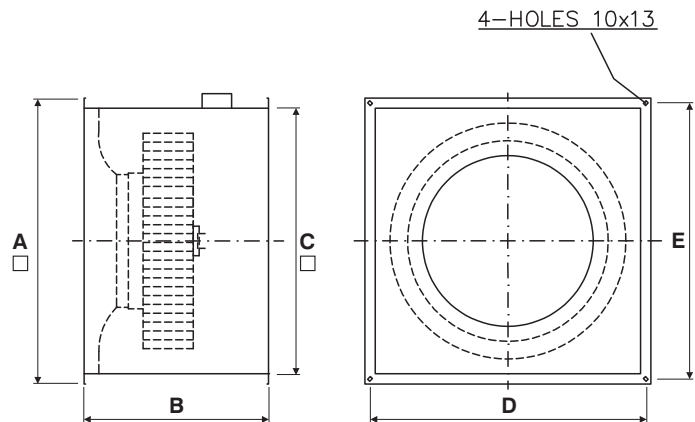

Issue 2018.06

CFM Airsystems reserve the right to change design without any notice or obligation. Please refer to your local CFM Airsystems representatives for technical and installation details.



FS 604302